

# 1. Duellen Vänster

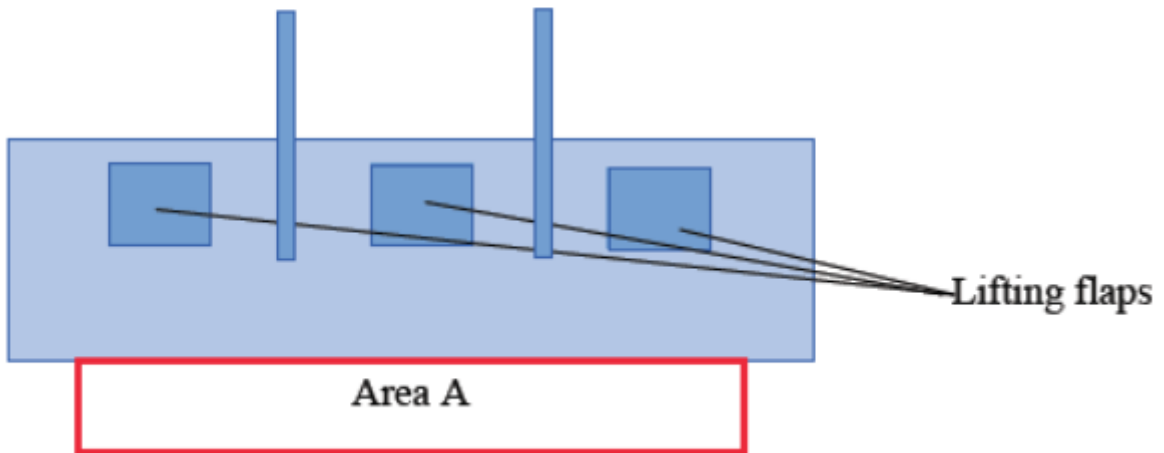
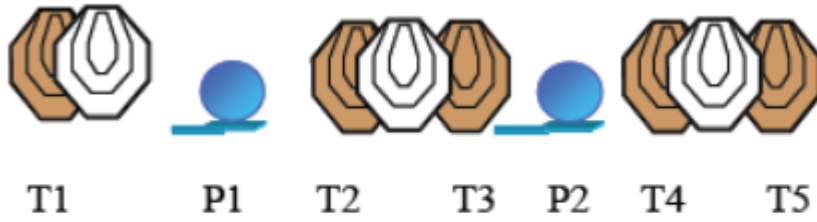

|         |                                    |            |       |
|---------|------------------------------------|------------|-------|
| CoF     | Comstock - Short                   | Points     | 60 p  |
| Targets | 5 paper, 2 plates, Total 7 targets | Min rounds | 12    |
| Firearm | Handgun                            | Match-%    | 5.19% |

|                         |   |
|-------------------------|---|
| Procedure               | On start signal engage targets                          |
| Starting position       | Standing anywhere in area A, gun unloaded and holstered |
| Firearm ready condition |   |
| Start on                | Audible signal  |
| Stop on                 | Last shot   |
| Penalties               | As per current edition of rules                         |
| Safety angles           | L/R   |
| Setup notes             |   |

## 2. Duellen Höger

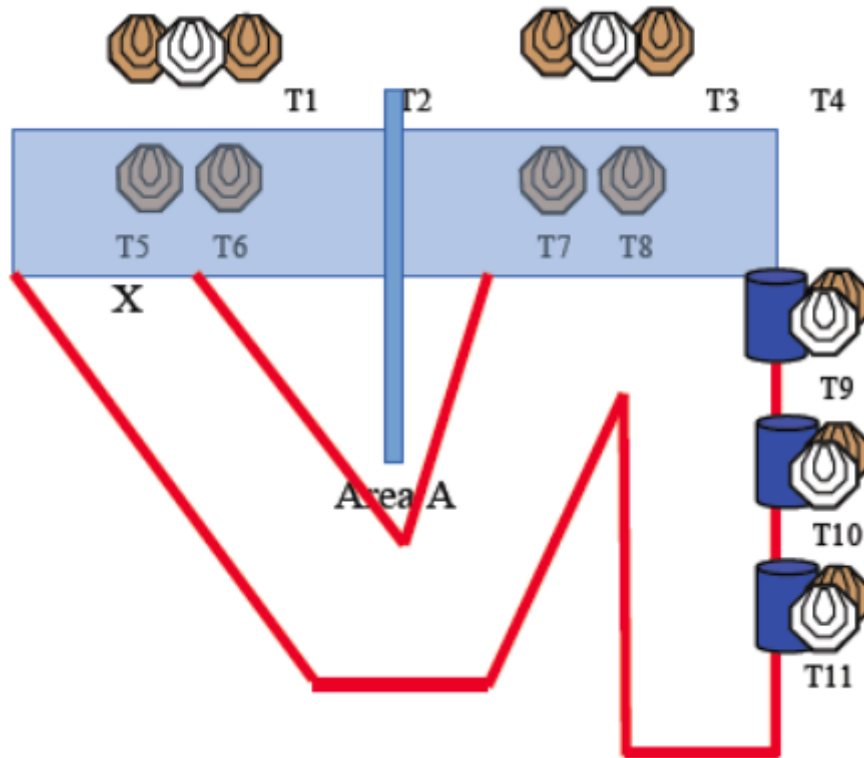

|         |                            |            |       |
|---------|----------------------------|------------|-------|
| CoF     | Comstock - Medium          | Points     | 110 p |
| Targets | 11 paper, Total 11 targets | Min rounds | 22    |
| Firearm | Handgun                    | Match-%    | 9.52% |

|                         |  |
|-------------------------|--|
| Procedure               | On start signal engage targets                     |
| Starting position       | Toes touching marks at X, gun loaded and holstered |
| Firearm ready condition |  |
| Start on                | Audible signal                                     |
| Stop on                 | Last shot  |
| Penalties               | As per current edition of rules                    |
| Safety angles           | L/R  |
| Setup notes             |  |

### 3. Gropen Yttre

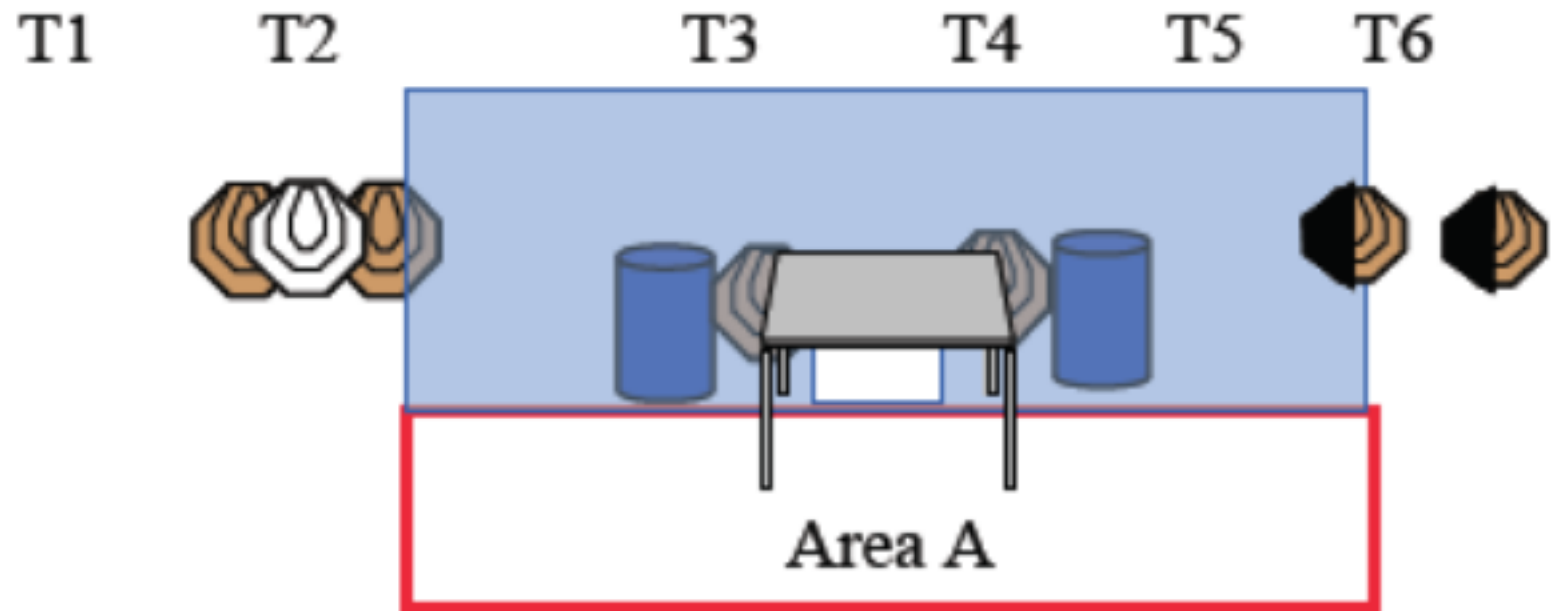

|         |                          |            |       |
|---------|--------------------------|------------|-------|
| CoF     | Comstock - Short         | Points     | 60 p  |
| Targets | 6 paper, Total 6 targets | Min rounds | 12    |
| Firearm | Handgun                  | Match-%    | 5.19% |

|                         |   |
|-------------------------|---|
| Procedure               | On start signal engage targets  |
| Starting position       | Standing anywhere in area A, Empty gun and all magazines placed on table. |
| Firearm ready condition |   |
| Start on                | Audible signal  |
| Stop on                 | Last shot   |
| Penalties               | As per current edition of rules   |
| Safety angles           | L/R   |
| Setup notes             |   |

## 4. Gropen Inre

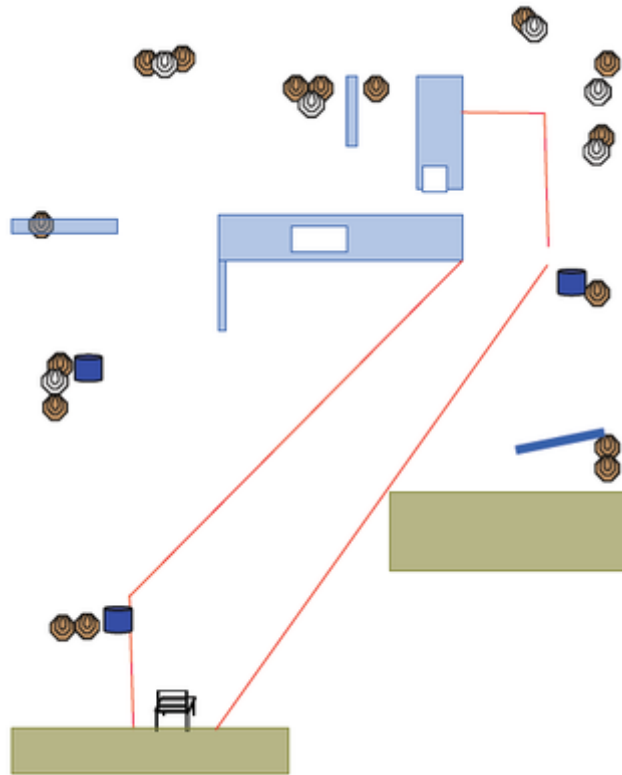

|         |                            |            |        |
|---------|----------------------------|------------|--------|
| CoF     | Comstock - Long            | Points     | 160 p  |
| Targets | 16 paper, Total 16 targets | Min rounds | 32     |
| Firearm | Handgun                    | Match-%    | 13.85% |

|                         |  |
|-------------------------|--|
| Procedure               | On start signal engage targets                               |
| Starting position       | Sitting with one hand at each knee, gun empty and holstered. |
| Firearm ready condition |  |
| Start on                | Audible signal   |
| Stop on                 | Last shot  |
| Penalties               | As per current edition of rules                              |
| Safety angles           | L/R  |
| Setup notes             |  |

# 5. Gruset Vänster

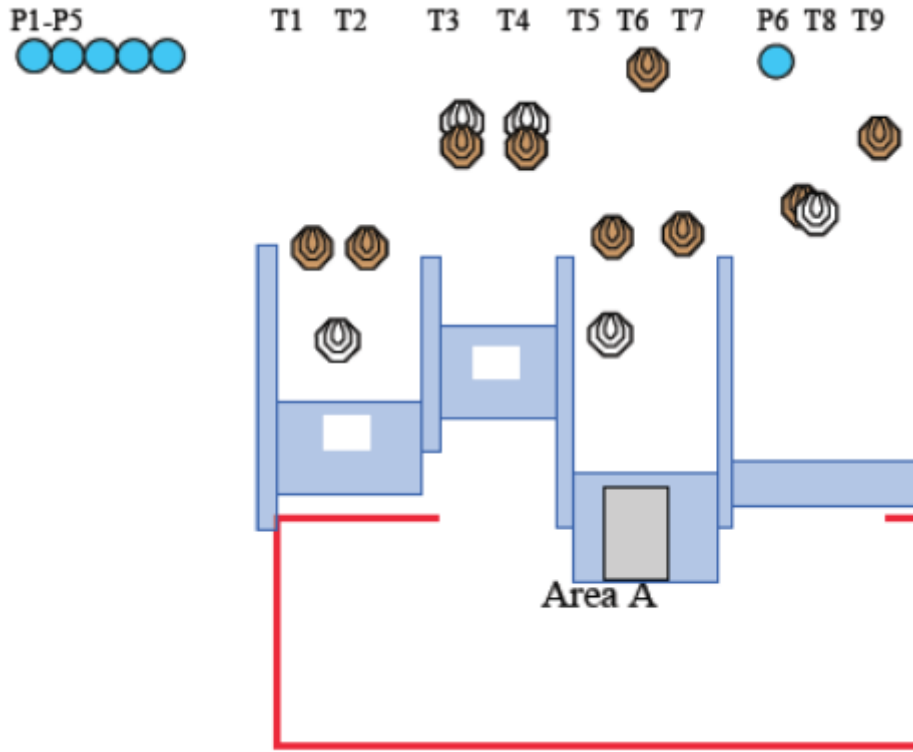

|         |                                     |            |        |
|---------|-------------------------------------|------------|--------|
| CoF     | Comstock - Medium                   | Points     | 120 p  |
| Targets | 9 paper, 6 plates, Total 15 targets | Min rounds | 24     |
| Firearm | Handgun                             | Match-%    | 10.39% |

|                         |  |
|-------------------------|--|
| Procedure               | On start signal engage targets                         |
| Starting position       | Standing anywhere in area A, gun loaded and holstered. |
| Firearm ready condition |  |
| Start on                | Audible signal   |
| Stop on                 | Last shot  |
| Penalties               | As per current edition of rules                        |
| Safety angles           | L/R  |
| Setup notes             |  |

## 6. Gruset Höger

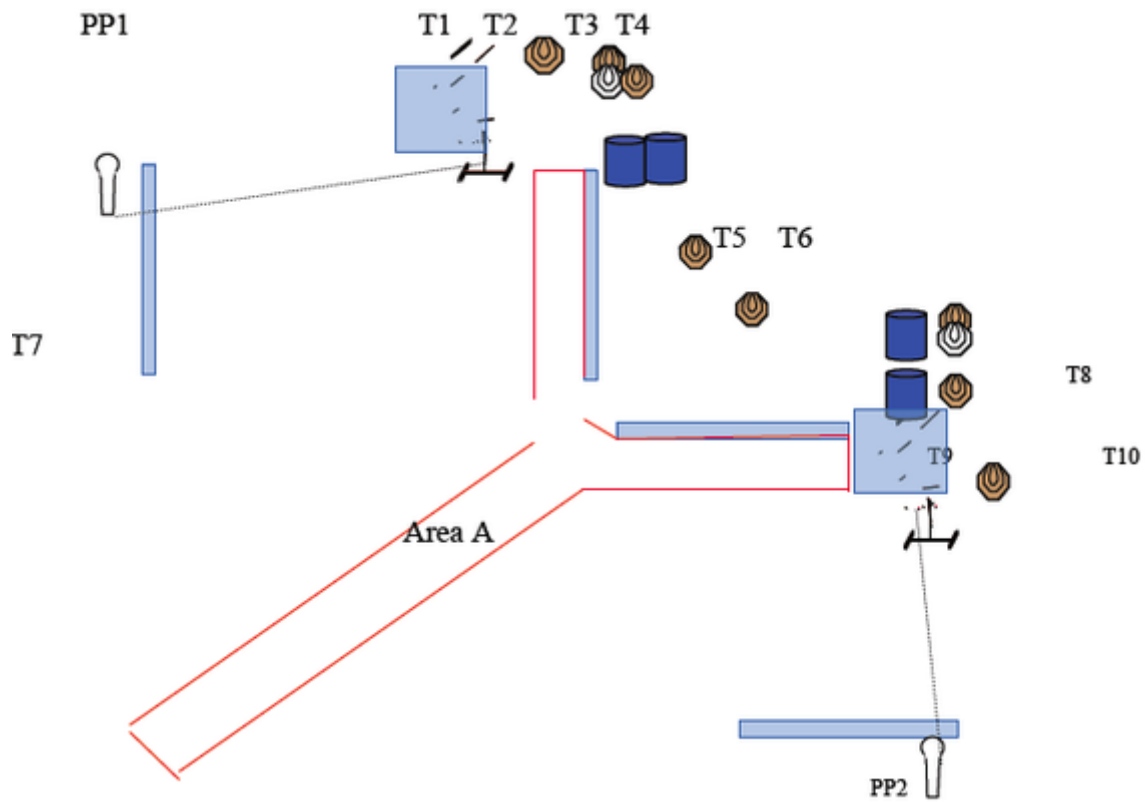

|         |                                      |            |       |
|---------|--------------------------------------|------------|-------|
| CoF     | Comstock - Medium                    | Points     | 110 p |
| Targets | 10 paper, 2 popper, Total 12 targets | Min rounds | 22    |
| Firearm | Handgun                              | Match-%    | 9.52% |

|                         |  |
|-------------------------|--|
| Procedure               | On start signal engage targets                         |
| Starting position       | Standing anywhere in area A, gun loaded and holstered. |
| Firearm ready condition |  |
| Start on                | Audible signal   |
| Stop on                 | Last shot  |
| Penalties               | As per current edition of rules                        |
| Safety angles           | L/R  |
| Setup notes             |  |

## 7. Lilla Mobben

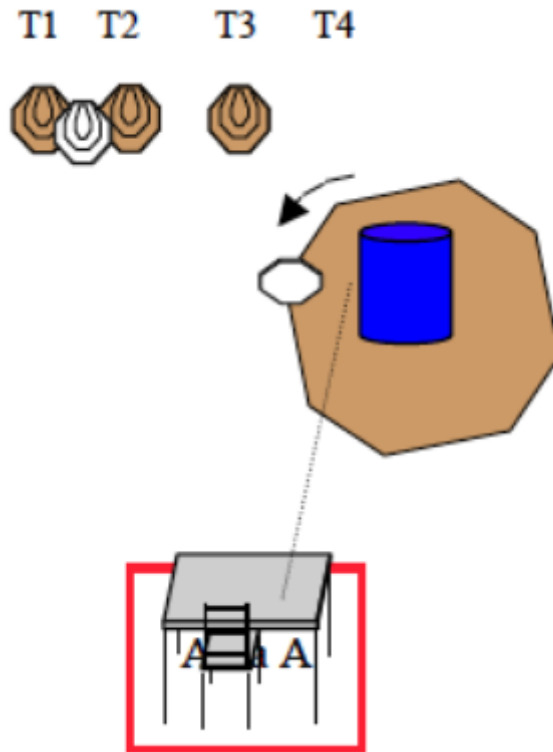

|         |                          |            |       |
|---------|--------------------------|------------|-------|
| CoF     | Comstock - Short         | Points     | 40 p  |
| Targets | 4 paper, Total 4 targets | Min rounds | 8     |
| Firearm | Handgun                  | Match-%    | 3.46% |

|                         |   |
|-------------------------|---|
| Procedure               | On start signal engage targets                                    |
| Starting position       | Sitting on chair with hands at marks, gun loaded placed on table. |
| Firearm ready condition |   |
| Start on                | Audible signal  |
| Stop on                 | Last shot   |
| Penalties               | As per current edition of rules                                   |
| Safety angles           | L/R   |
| Setup notes             |   |

## 8. Mob Vänster

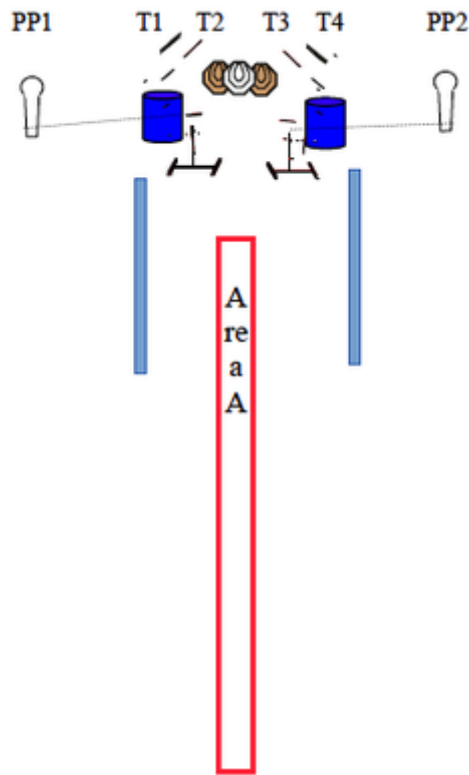

|         |                                    |            |       |
|---------|------------------------------------|------------|-------|
| CoF     | Comstock - Short                   | Points     | 50 p  |
| Targets | 4 paper, 2 popper, Total 6 targets | Min rounds | 10    |
| Firearm | Handgun                            | Match-%    | 4.33% |

|                         |  |
|-------------------------|--|
| Procedure               | On start signal engage targets                         |
| Starting position       | Standing anywhere in area A, gun loaded and holstered. |
| Firearm ready condition |  |
| Start on                | Audible signal   |
| Stop on                 | Last shot  |
| Penalties               | As per current edition of rules                        |
| Safety angles           | L/R  |
| Setup notes             |  |



# 9. Mob Höger

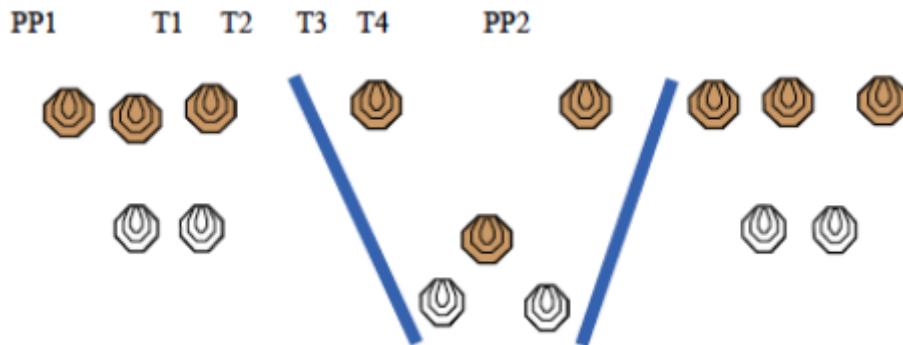

Area A

|         |                          |            |       |
|---------|--------------------------|------------|-------|
| CoF     | Comstock - Short         | Points     | 45 p  |
| Targets | 9 paper, Total 9 targets | Min rounds | 9     |
| Firearm | Handgun                  | Match-%    | 3.90% |

|                         |  |
|-------------------------|--|
| Procedure               | On start signal engage targets with 1 (one) shot each. |
| Starting position       | Standing anywhere in area A, gun loaded and holstered. |
| Firearm ready condition |  |
| Start on                | Audible signal   |
| Stop on                 | Last shot  |
| Penalties               | As per current edition of rules                        |
| Safety angles           | L/R  |
| Setup notes             |  |

# 10. Café Söder

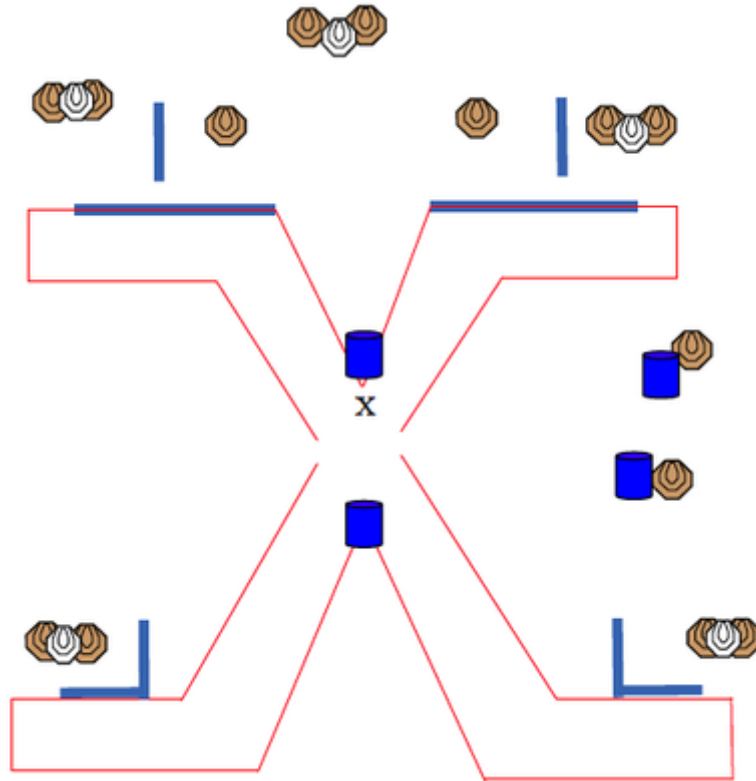

|         |                            |            |        |
|---------|----------------------------|------------|--------|
| CoF     | Comstock - Long            | Points     | 140 p  |
| Targets | 14 paper, Total 14 targets | Min rounds | 28     |
| Firearm | Handgun                    | Match-%    | 12.12% |

|                         |  |
|-------------------------|--|
| Procedure               | On start signal engage targets   |
| Starting position       | Hands touching barrel, gun empty and all magazines placed on the barrel. |
| Firearm ready condition |  |
| Start on                | Audible signal   |
| Stop on                 | Last shot  |
| Penalties               | As per current edition of rules  |
| Safety angles           | L/R  |
| Setup notes             |  |

# 11. Gräset Vänster

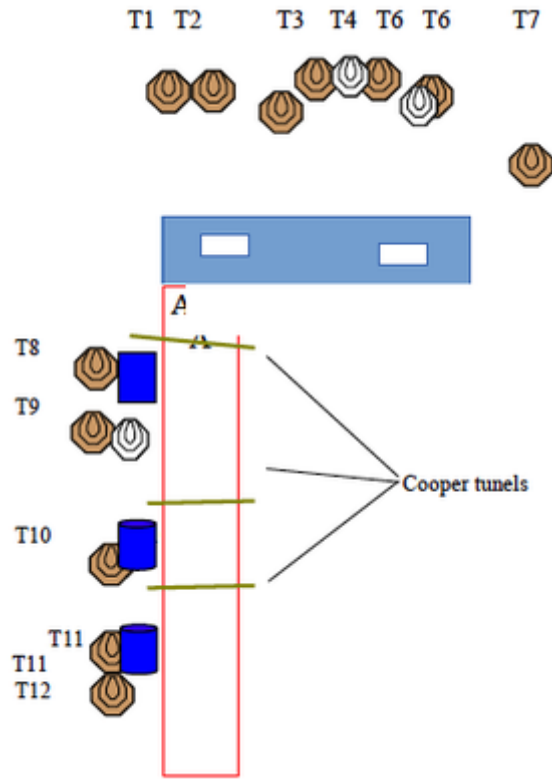

|         |                            |            |        |
|---------|----------------------------|------------|--------|
| CoF     | Comstock - Medium          | Points     | 120 p  |
| Targets | 12 paper, Total 12 targets | Min rounds | 24     |
| Firearm | Handgun                    | Match-%    | 10.39% |

|                         |  |
|-------------------------|--|
| Procedure               | On start signal engage targets                         |
| Starting position       | Standing anywhere in area A, gun loaded and holstered. |
| Firearm ready condition |  |
| Start on                | Audible signal   |
| Stop on                 | Last shot  |
| Penalties               | As per current edition of rules                        |
| Safety angles           | L/R  |
| Setup notes             |  |

# 12. Gräset Mitten

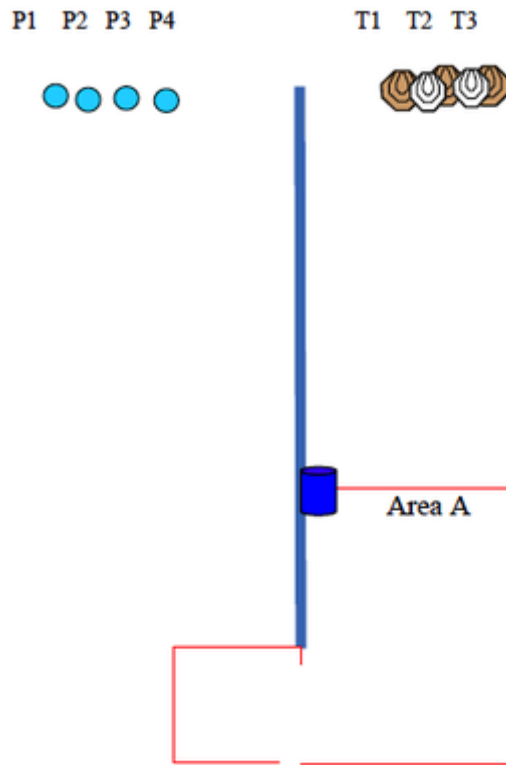

|         |                                    |            |       |
|---------|------------------------------------|------------|-------|
| CoF     | Comstock - Short                   | Points     | 50 p  |
| Targets | 3 paper, 4 plates, Total 7 targets | Min rounds | 10    |
| Firearm | Handgun                            | Match-%    | 4.33% |

|                         |   |
|-------------------------|---|
| Procedure               | On start signal engage targets  |
| Starting position       | Standing anywhere in area A, gun epty on one of the barrels and the magazines to be used on the other |
| Firearm ready condition |   |
| Start on                | Audible signal  |
| Stop on                 | Last shot   |
| Penalties               | As per current edition of rules   |
| Safety angles           | L/R   |
| Setup notes             |   |

# 13. Gräset Höger

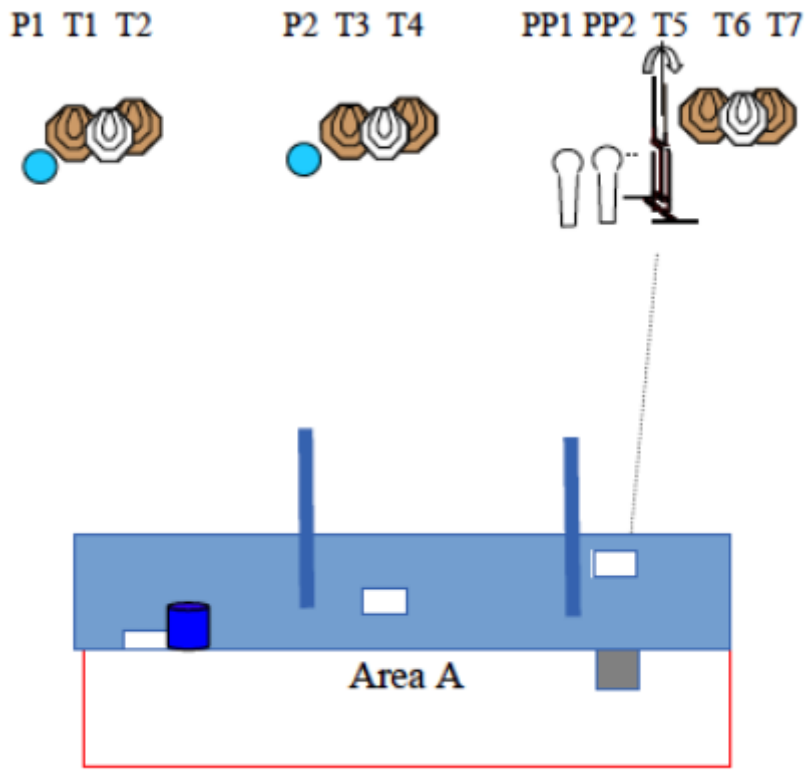

|         |   |            |       |
|---------|---|------------|-------|
| CoF     | Comstock - Medium                             | Points     | 90 p  |
| Targets | 7 paper, 2 popper, 2 plates, Total 11 targets | Min rounds | 18    |
| Firearm | Handgun                                       | Match-%    | 7.79% |

|                         |  |
|-------------------------|--|
| Procedure               | On start signal engage targets                                       |
| Starting position       | Heels touching mark (X), gun empty in holster and magazines in belt. |
| Firearm ready condition |  |
| Start on                | Audible signal   |
| Stop on                 | Last shot  |
| Penalties               | As per current edition of rules                                      |
| Safety angles           | L/R  |
| Setup notes             |  |