

# 1. Stage 1

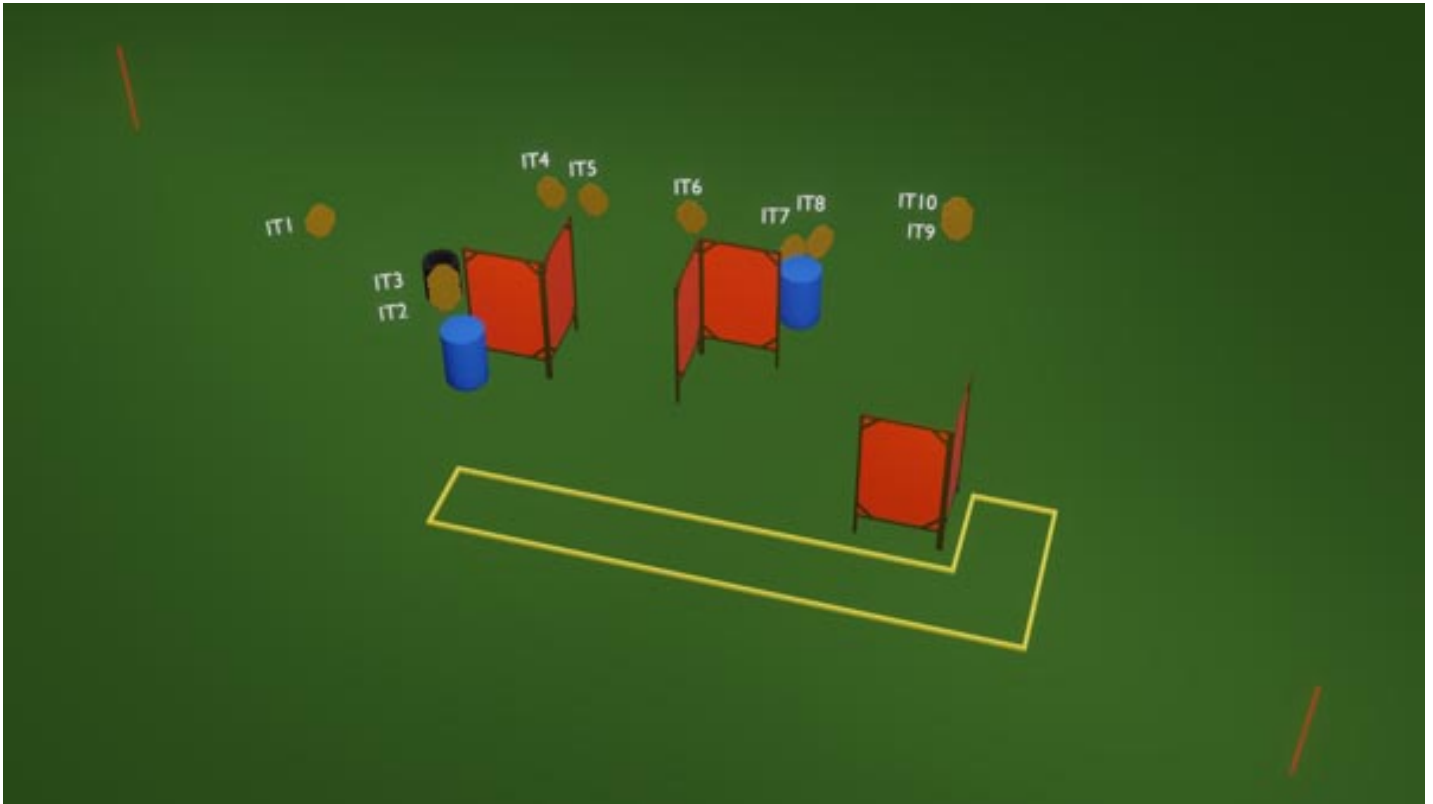

CoF	Comstock - Medium	Points	100 p
Targets	10 paper, Total 10 targets	Min rounds	20
Firearm	Handgun	Match-%	9.85%

Procedure	Upon signal engage targets
Starting position	Standing anywhere inside the area
Firearm ready condition	
Start on	Audible signal
Stop on	Last shot
Penalties	As per current edition of rules
Safety angles	Marked by red poles
Setup notes	

## 2. Stage 2

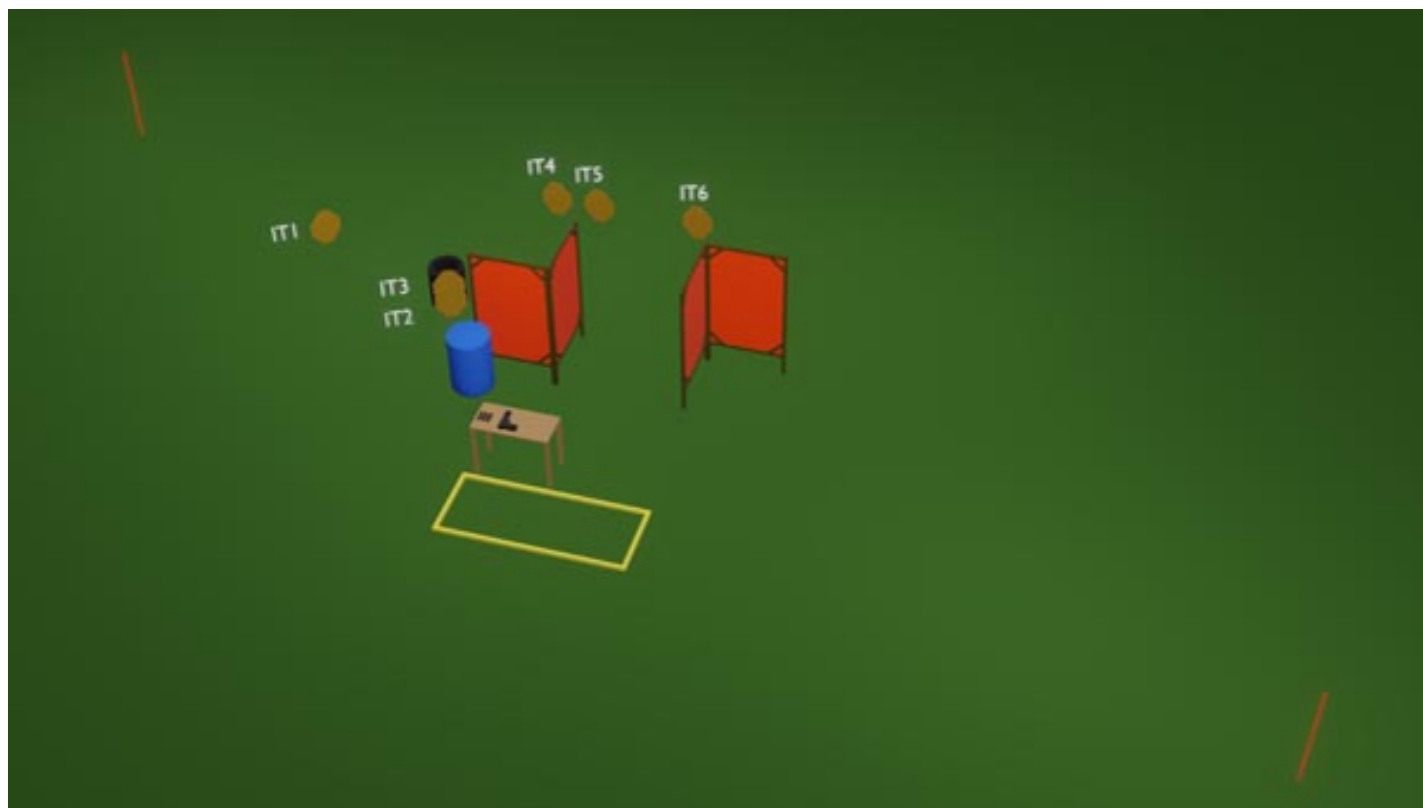

CoF	Comstock - Short	Points	60 p
Targets	6 paper, Total 6 targets	Min rounds	12
Firearm	Handgun	Match-%	5.91%

Procedure	Upon signal engage targets
Starting position	Standing anywhere inside the area
Firearm ready condition	Chamber and magwell empty on the table along with to be used magazines
Start on	Audible signal
Stop on	Last shot
Penalties	As per current edition of rules
Safety angles	Marked by red poles
Setup notes	

### 3. Stage 3

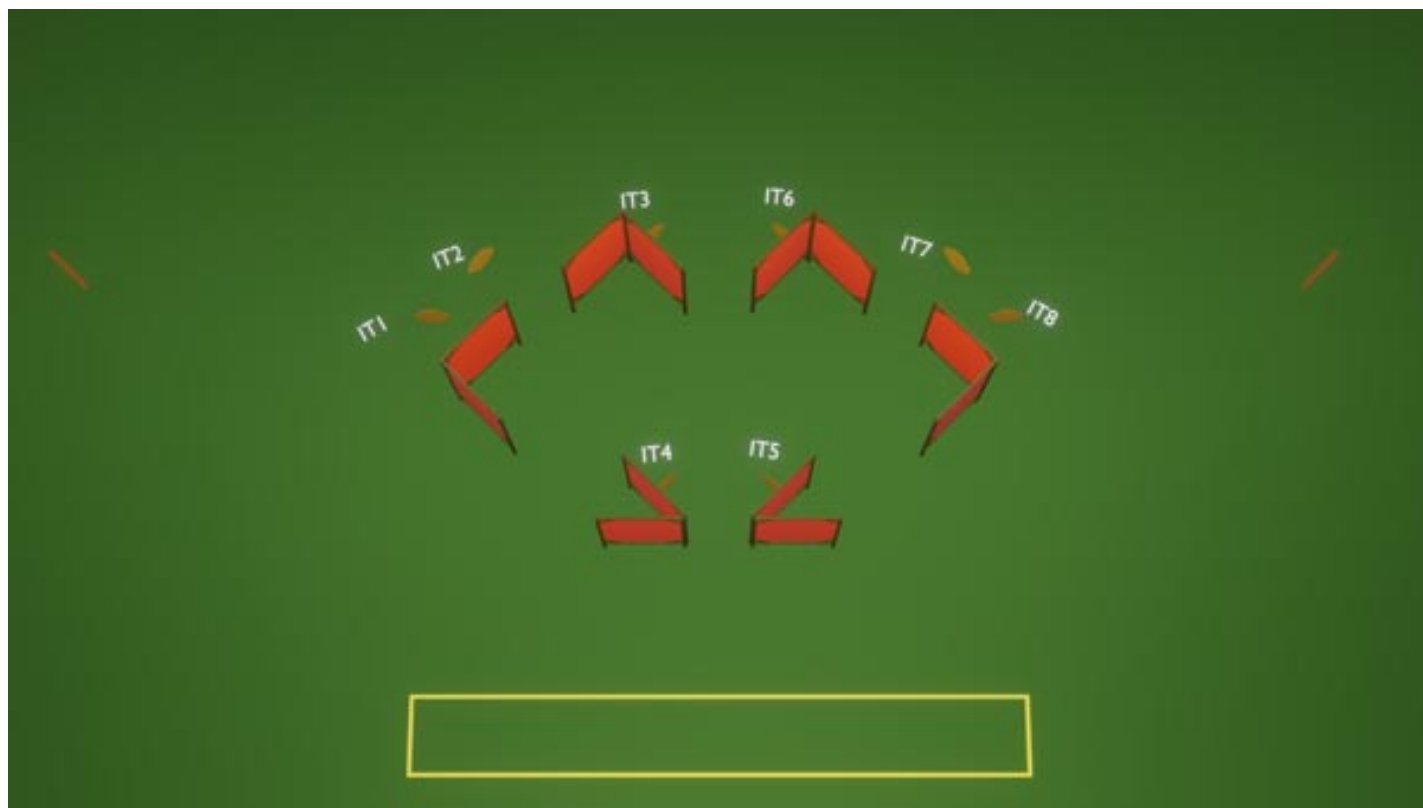

CoF	Comstock - Medium	Points	80 p
Targets	8 paper, Total 8 targets	Min rounds	16
Firearm	Handgun	Match-%	7.88%

Procedure	Upon signal engage targets
Starting position	Standing anywhere inside the area
Firearm ready condition	
Start on	Audible signal
Stop on	Last shot
Penalties	As per current edition of rules
Safety angles	Marked by red poles
Setup notes	

## 4. Stage 4

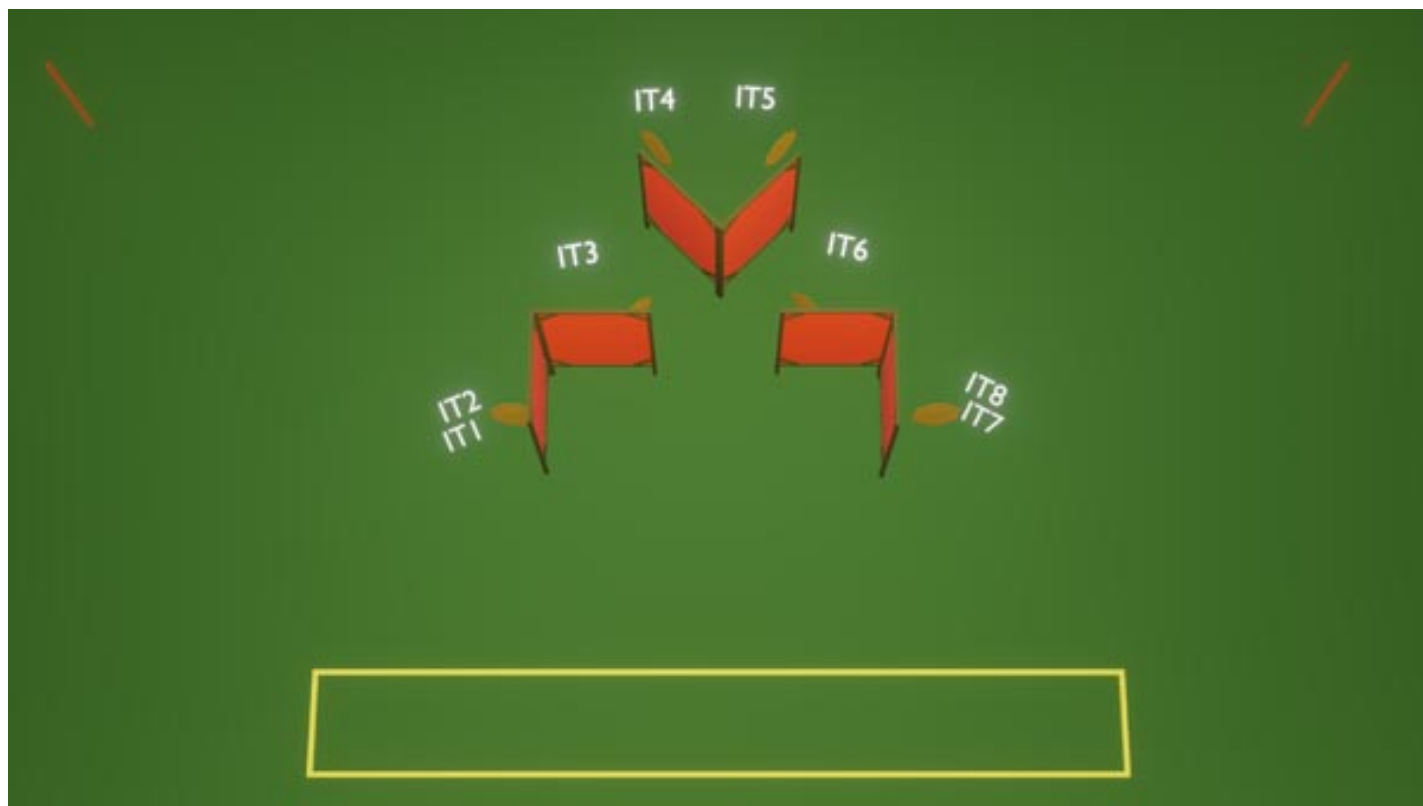

CoF	Comstock - Medium	Points	80 p
Targets	8 paper, Total 8 targets	Min rounds	16
Firearm	Handgun	Match-%	7.88%

Procedure	Upon signal engage targets
Starting position	Standing anywhere inside the area
Firearm ready condition	
Start on	Audible signal
Stop on	Last shot
Penalties	As per current edition of rules
Safety angles	Marked by red poles
Setup notes	

## 5. Stage 5

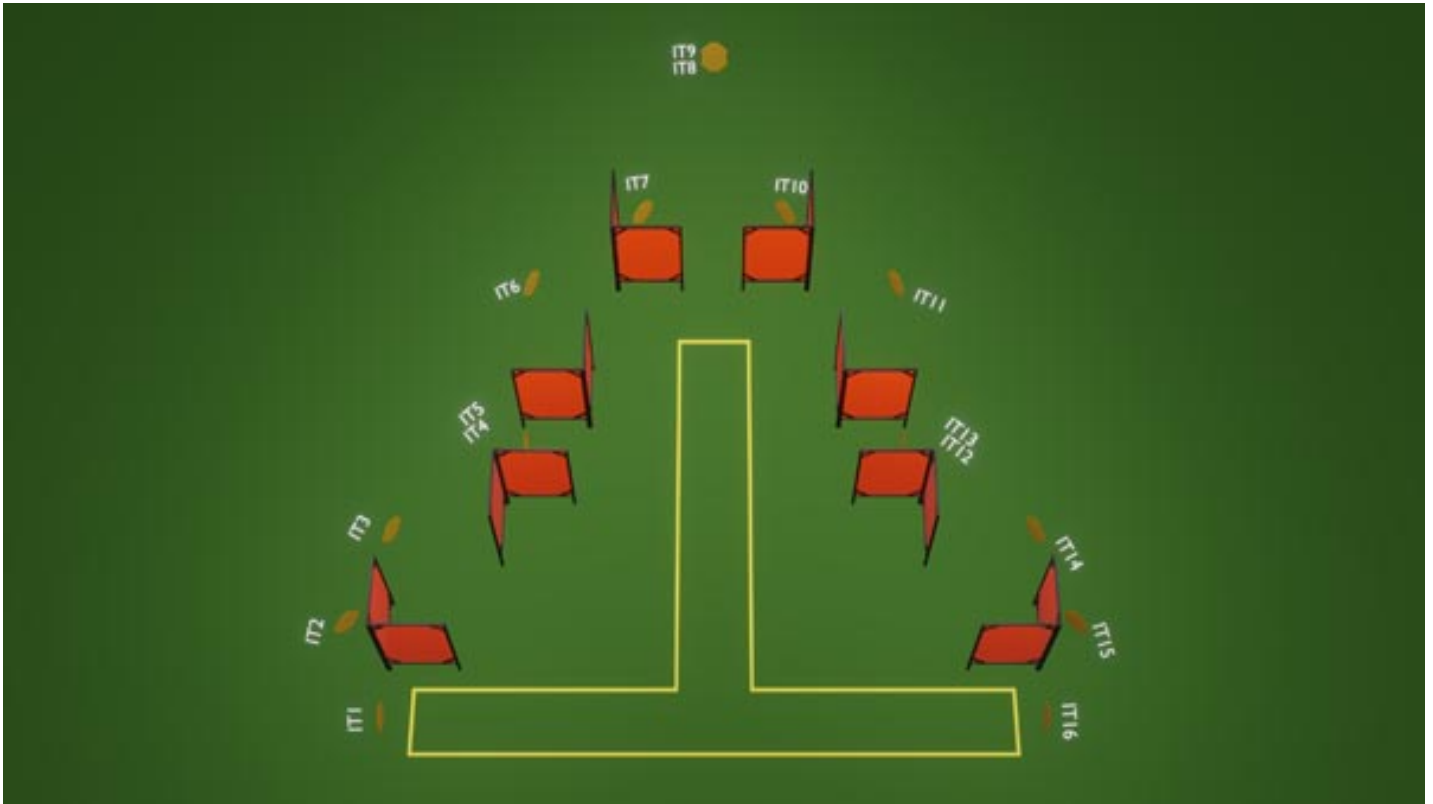

CoF	Comstock - Long	Points	160 p
Targets	16 paper, Total 16 targets	Min rounds	32
Firearm	Handgun	Match-%	15.76%

Procedure	Upon signal engage targets
Starting position	Standing anywhere inside the area
Firearm ready condition	
Start on	Audible signal
Stop on	Last shot
Penalties	As per current edition of rules
Safety angles	
Setup notes	

## 6. Stage 6

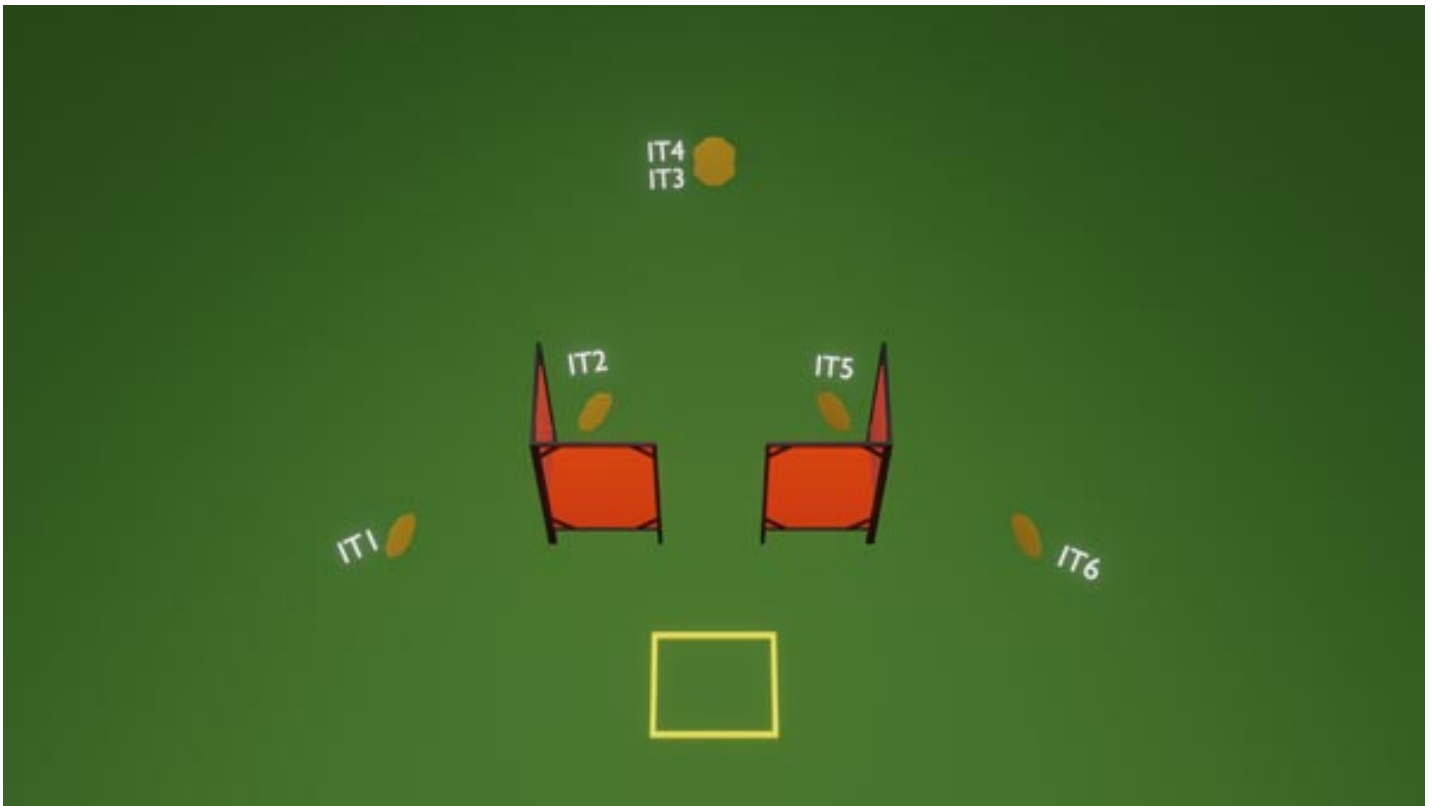

CoF	Comstock - Short	Points	60 p
Targets	6 paper, Total 6 targets	Min rounds	12
Firearm	Handgun	Match-%	5.91%

Procedure	Upon signal engage targets
Starting position	Standing anywhere inside the area
Firearm ready condition	
Start on	Audible signal
Stop on	Last shot
Penalties	As per current edition of rules
Safety angles	
Setup notes	

## 7. Stage 7

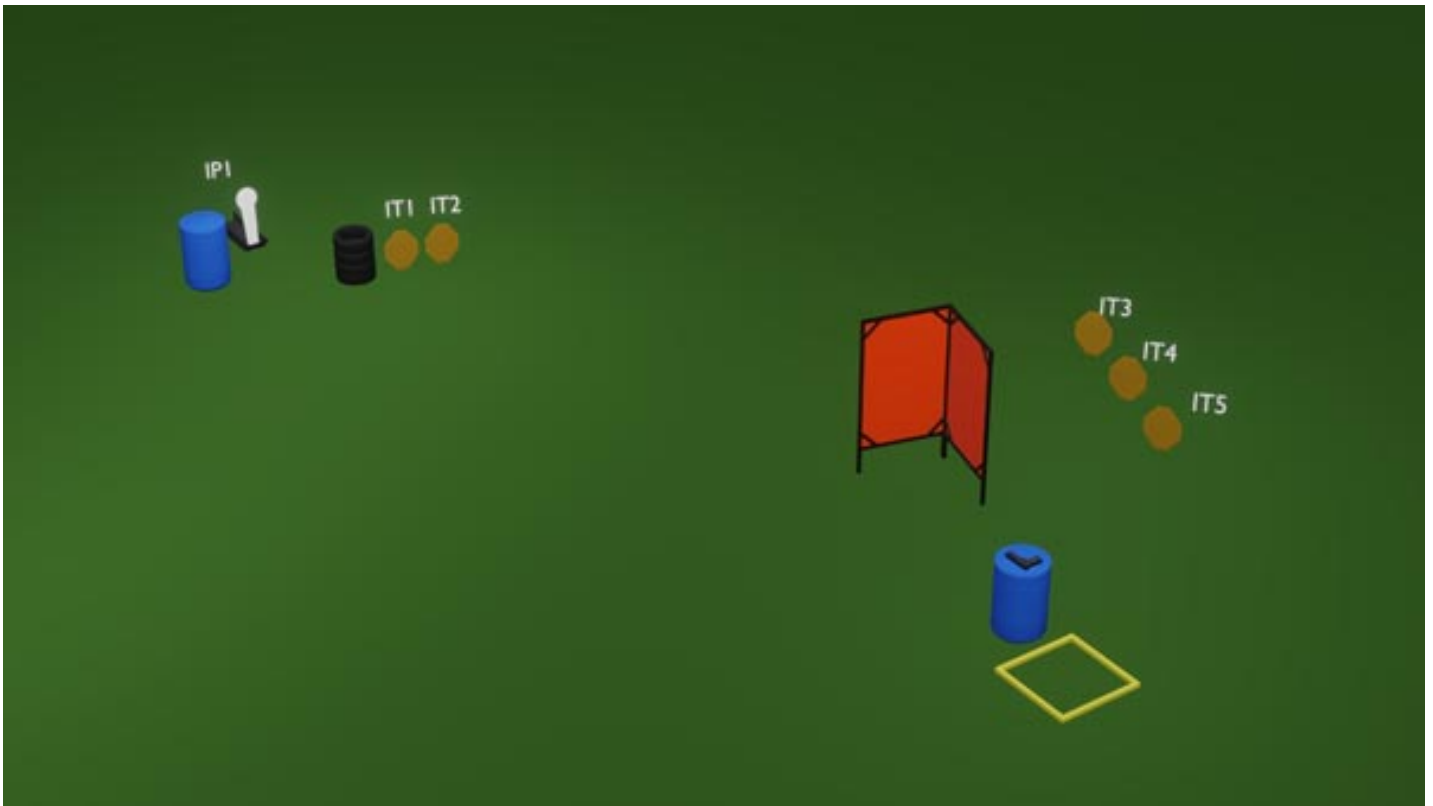

CoF	Comstock - Short	Points	55 p
Targets	5 paper, 1 popper, Total 6 targets	Min rounds	11
Firearm	Handgun	Match-%	5.42%

Procedure	Upon signal engage targets
Starting position	Standing anywhere inside the area
Firearm ready condition	Chamber empty, magazine inserted on the barrel
Start on	Audible signal
Stop on	Last shot
Penalties	As per current edition of rules
Safety angles	
Setup notes	

## 8. Stage 8

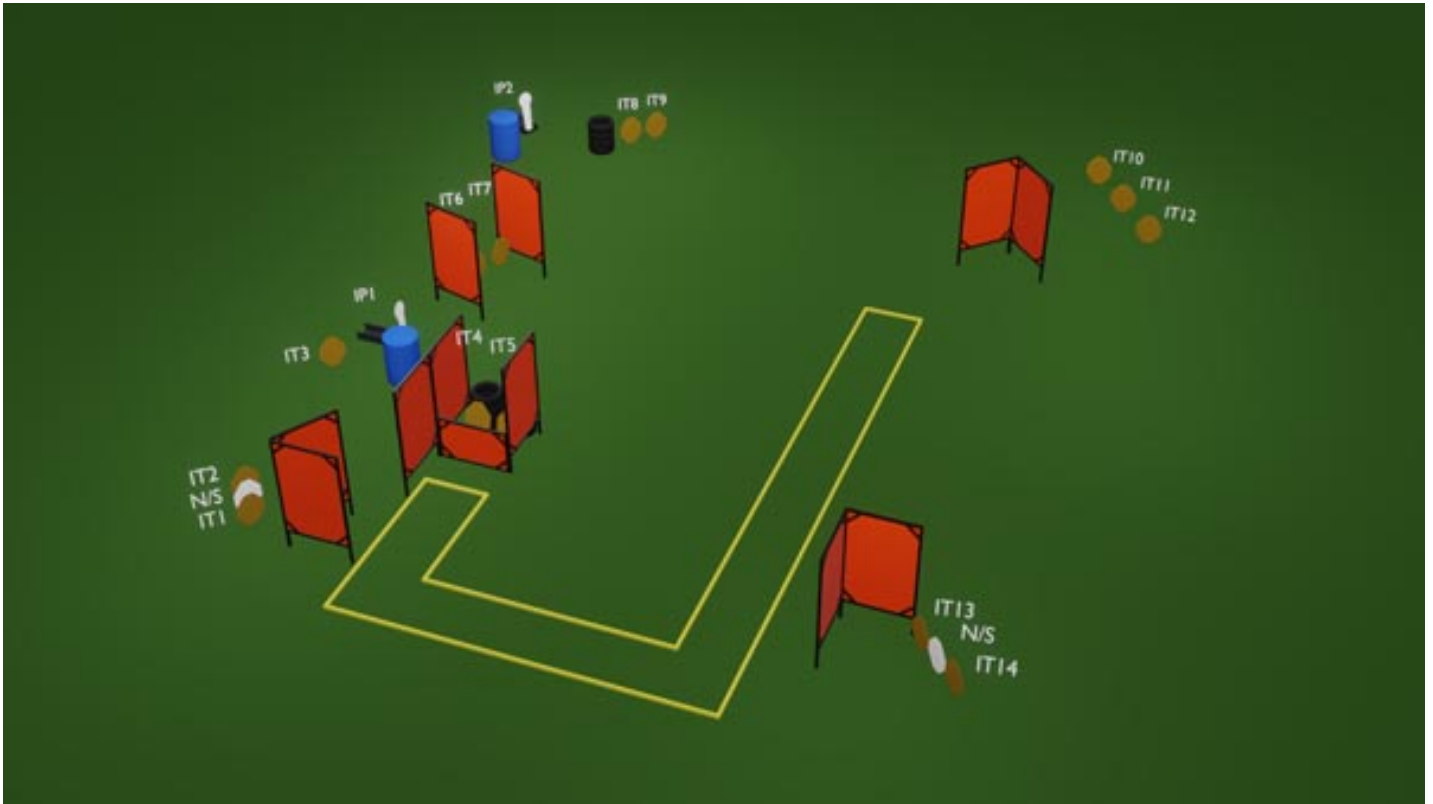

CoF	Comstock - Long	Points	150 p
Targets	14 paper, 2 popper, 2 no-shoot, Total 16 targets	Min rounds	30
Firearm	Handgun	Match-%	14.78%

Procedure	Upon signal engage targets
Starting position	Standing anywhere inside the area
Firearm ready condition	
Start on	Audible signal
Stop on	Last shot
Penalties	As per current edition of rules
Safety angles	
Setup notes	



## 9. Stage 9

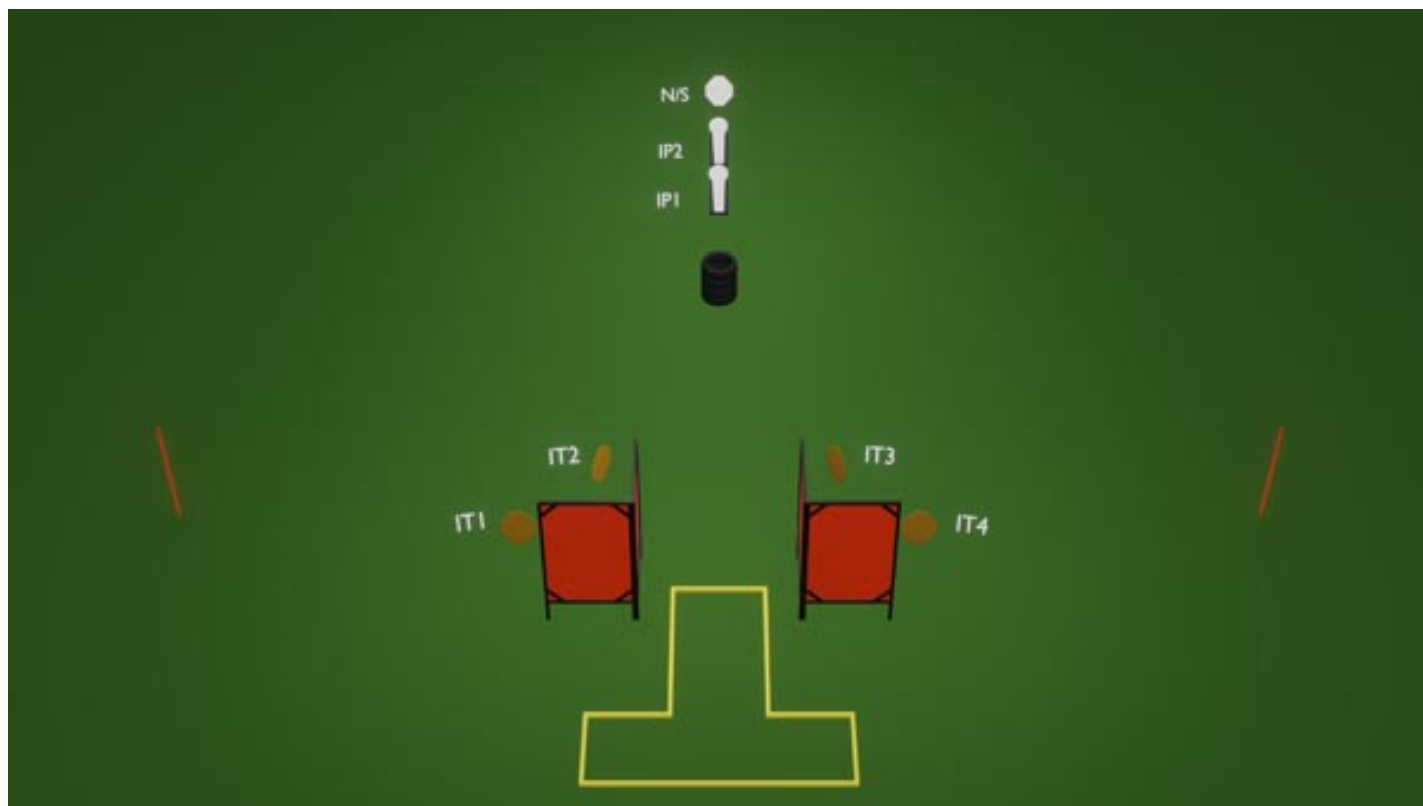

CoF	Comstock - Short	Points	50 p
Targets	4 paper, 2 popper, 1 no-shoot, Total 6 targets	Min rounds	10
Firearm	Handgun	Match-%	4.93%

Procedure	Upon signal engage targets
Starting position	Standing anywhere inside the area
Firearm ready condition	
Start on	Audible signal
Stop on	Last shot
Penalties	As per current edition of rules
Safety angles	Marked by red poles
Setup notes	

# 10. Stage 10

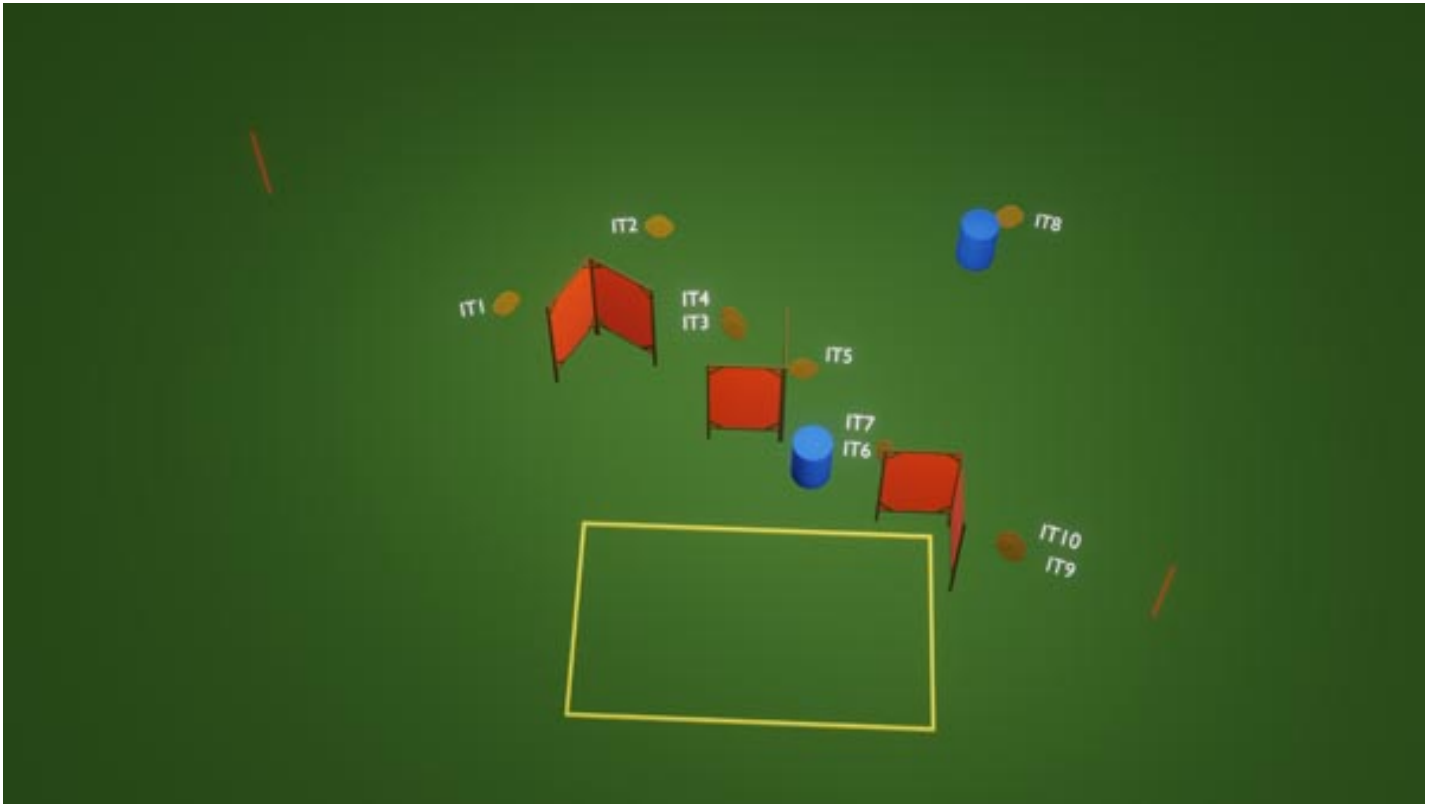

CoF	Comstock - Medium	Points	100 p
Targets	10 paper, Total 10 targets	Min rounds	20
Firearm	Handgun	Match-%	9.85%

Procedure	Upon signal engage targets
Starting position	Standing anywhere inside the area
Firearm ready condition	
Start on	Audible signal
Stop on	Last shot
Penalties	As per current edition of rules
Safety angles	Marked by red poles
Setup notes	

# 11. Stage 11

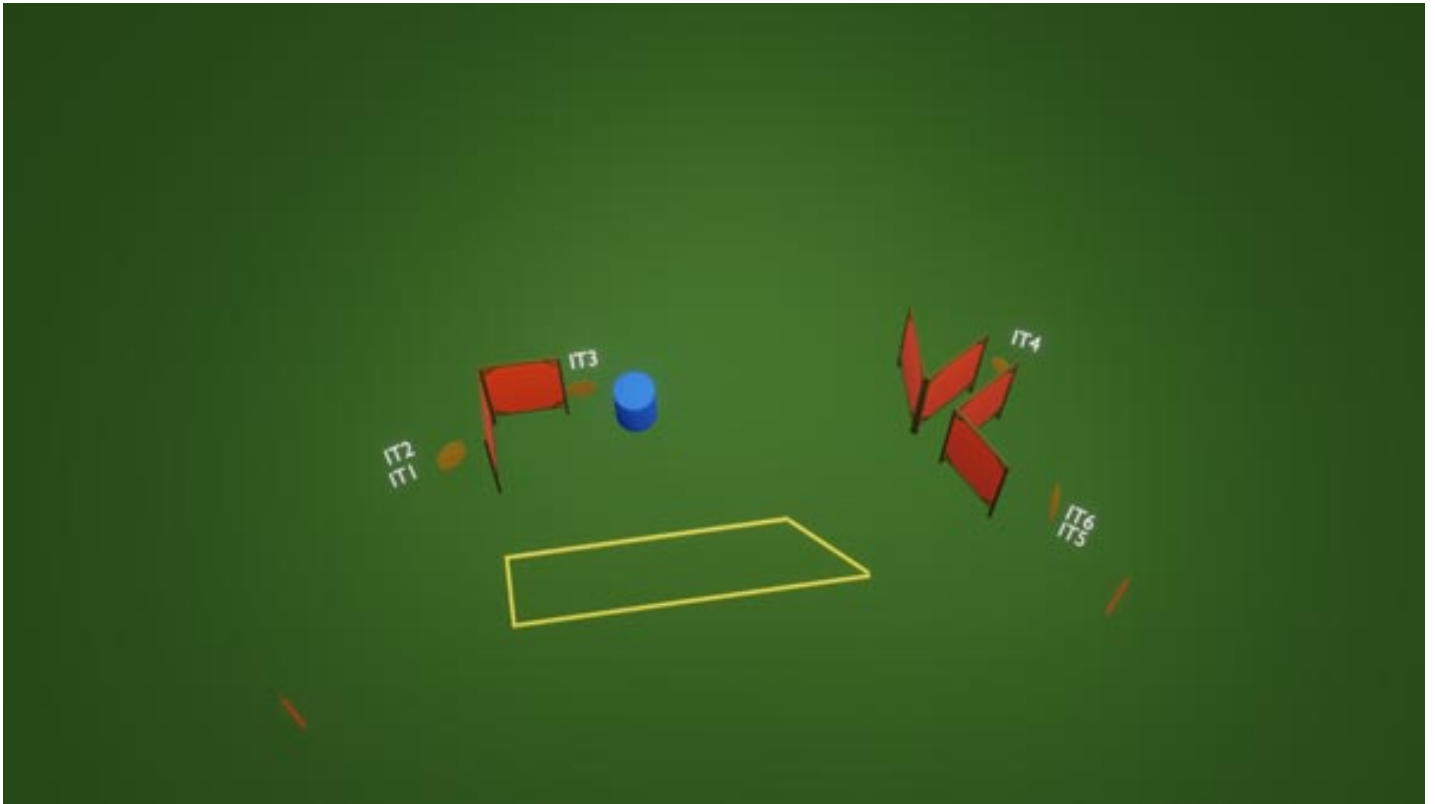

CoF	Comstock - Short	Points	60 p
Targets	6 paper, Total 6 targets	Min rounds	12
Firearm	Handgun	Match-%	5.91%

Procedure	Upon signal engage targets
Starting position	Standing anywhere inside the area
Firearm ready condition	
Start on	Audible signal
Stop on	Last shot
Penalties	As per current edition of rules
Safety angles	Marked by red poles
Setup notes	

## 12. Stage 12

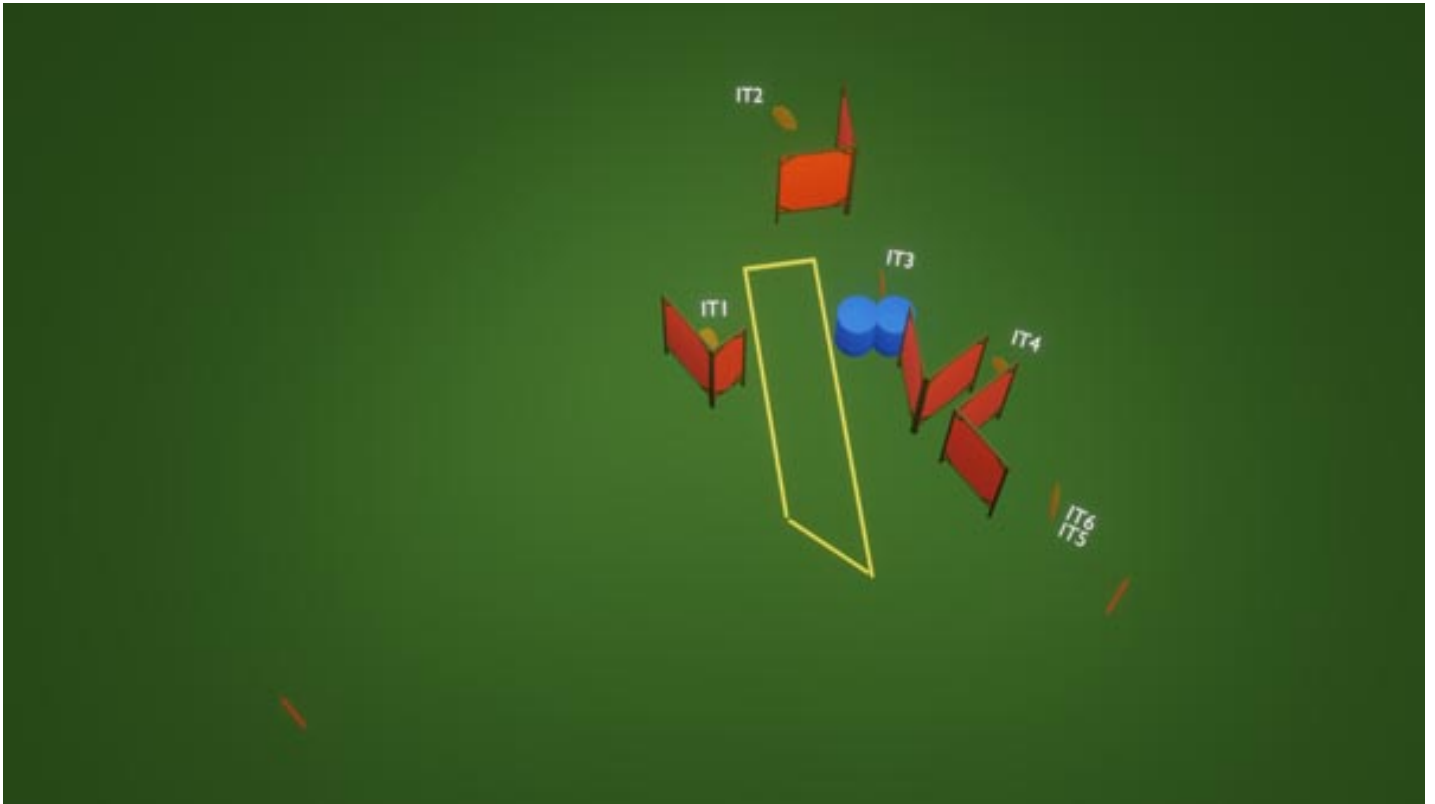

CoF	Comstock - Short	Points	60 p
Targets	6 paper, Total 6 targets	Min rounds	12
Firearm	Handgun	Match-%	5.91%

Procedure	Upon signal engage targets
Starting position	Standing anywhere inside the area
Firearm ready condition	
Start on	Audible signal
Stop on	Last shot
Penalties	As per current edition of rules
Safety angles	Marked by red poles
Setup notes	